

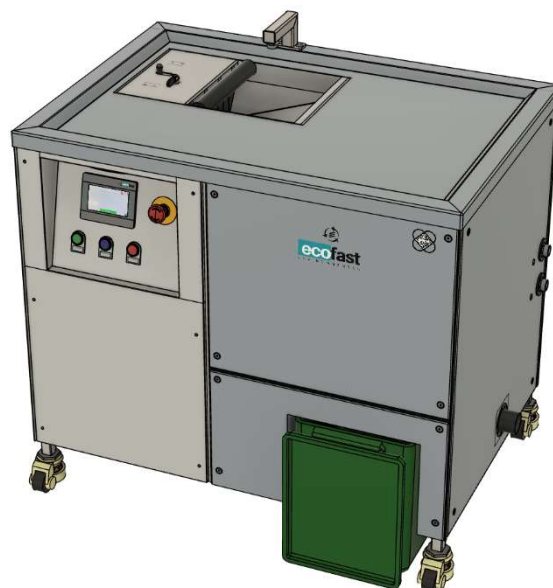

Product Manual

D1000 – Food Waste Dehydra
WasteStation



VERSION 1.8

Model Number **D1000-0 / D1000-1 / D1000-2**

Customer / Site **INSERT CUSTOMER NAME**

Serial Number **EXAMPLE – 10-1022-002**

Table of contents

PRODUCT DIMENSIONS	3
IMPORTANT NOTICE	3
HEALTH & SAFETY	4
INSTALLATION INSTRUCTIONS	5
WATER & WASTE CONNECTIONS	5
ELECTRICAL INSTALLATION	6
OPERATOR INSTRUCTIONS	8
WARRANTY DETAILS	12
TROUBLE SHOOTING & FAULT FINDING	12
ERROR FAULT CODES	12
SPARES PARTS & EXPLODED DIAGRAMS	13
UKCA & CE CERTIFICATE OF CONFORMANCE	16 +17
TESTING & APPROVALS	19
WHERE TO FIND FURTHER HELP / CONTACT DETAILS	25
DISPOSAL OF MACHINE / END OF LIFE ACTIONS	26

Product Dimensions

SIDE VIEW

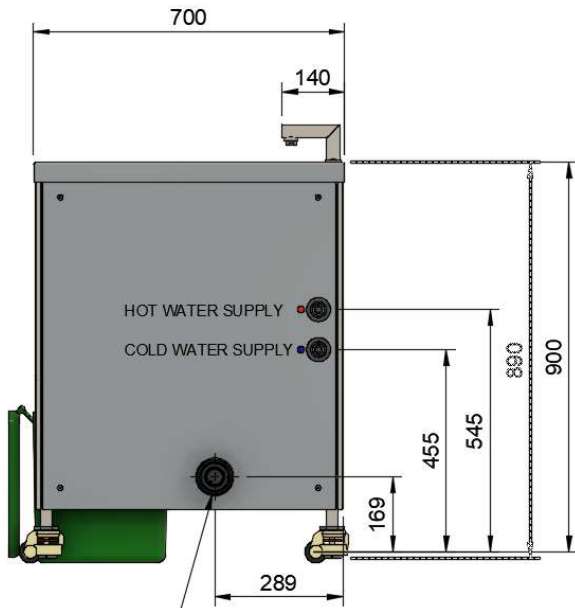

FRONT VIEW

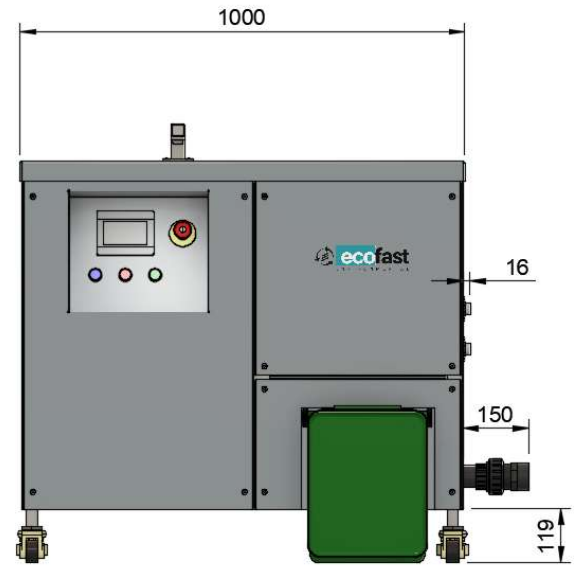

RECOVERED WATER



Baffle & noise reduction cover including safety interlock mechanism with cutlery saver as standard

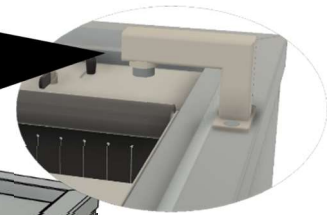

Heavy duty Water Airbreak

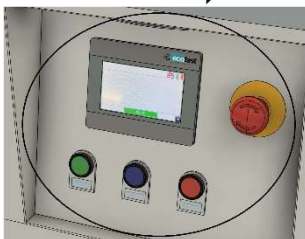

Operator Control Panel

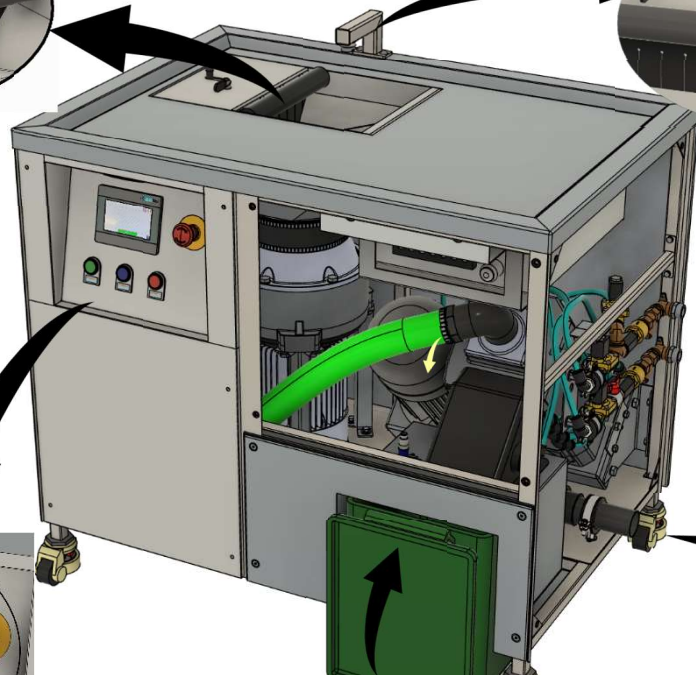

Food waste receptacle / collection bin

Recovered Wastewater

Important Notice

This manual constitutes an integral part of the product and must always be readily available. The manufacturer reserves the right to update the manual with modifications or upgrades without notice.

All tasks detailed in this product manual must be undertaken by qualified personnel.

The machine should not be operated without having read and understood the user manual beforehand, misuse of the machine can result in damage to the machine and the warranty being void.

Health & Safety

These signs are actively used in this Product manual and on the product itself.



Attention Live parts



Isolate the power and unplug the machine



Wear gloves



Wear foot protection

Technical Details (Covers model numbers D1000-0/1/2)

D1000 – Food Waste Station Mark III	(DxWxH)
D1000 Dewaterer Dimensions (mm)	700x1000x900
Water connections – 1 x Cold Water 1 x Hot water for cleaning system only	15mm with ¾ standard hose connections
Water Consumption (flow rate) Cold Water	8-10 litres per minute
Water Consumption (flow rate) Hot Water	3 litres per cleaning cycle
Discharge height (mm)	169
Discharge size (mm & inches)	50 / 2"
Capacity (Food Waste) per minute / hour (kg)	13 / 800
Air-break	Supplied as standard
Weight (kg)	197
Decibels (dB) – dependant on operation	70-80
Electrical Phase	3
Motor voltage (v)	380-415
Motor frequency (Hz)	50
Motor kilowatt (kW) – Macerator / Disposer	2.2
Motor kilowatt (kW) – Pump	0.75
Motor kilowatt (kW) – Dewaterer	1.1
Total kilowatt (kW)	4.05
Amps	16
Electrical Connection (see installation guide)	Flying leads to be hard wired to site connection
Cutlery Saver	Supplied as standard

Installation Instructions



After Unpacking and locating the machine to its operation area.



Ensure the foot mechanism is lowered into the correct position ensuring the WasteStation wheels are not in contact with the floor and the unit cannot move.

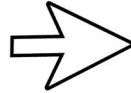

Water & Waste Connections (local regulations apply).

Both the **cold** water and **hot** water connections are colour coded and come with colour coded water hoses. These have standard European washing machine fittings (3/4" threaded connections) and must have a 3 bar pressure (± 0.5 bar) water supply. High water pressure & temperature could prevent the unit working.

Water connections should be located within 1 meter of the installation location prior to final positioning of the machine. Hot water suppliers need to be supplied via a braked tank and supplied at a temperature between 30-50°C. Cold water supply dependant on model purchased.

The waste connection is a standard 2" or $\text{Ø}63\text{mm}$ pipe fitting. We suggest using a rubber straight connector between the WasteStation and the site plumbing fittings. This will avoid any issues between types of fittings used.

The size of the product outlet must not be reduced, the drainpipe should run into 54mm outside diameter pipe work as far as its junction with the main pipe or outside manhole connection. The length of run between the machine and the main junction must be kept to a minimum and the pipe run must have a fall of at least 1° fall.

A running trap should be fitted, although "P" or "S" type traps **should not be used**. Do not use bottle traps. Changes of direction should be made by **swept bends** not elbows and cleaning eyes should be fitted where possible, in accordance with standard plumbing practice.

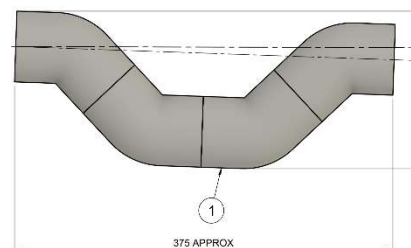

Copper pipe and compression fittings should be used, but plastic tubing is acceptable to most drainage authorities.

The WasteStations must have an independent waste pipe, **which does not also serve sinks, dishwashers and similar equipment.**

Should a grease trap or separator be used solely for the WasteStation, it must be specified by the supplier to suit the output of the WasteStation. If the unit outlet is positioned below tabling, it is important to use fittings, which give at least the minimum 220 mm clearance, required for service access. Ensure the installation complies with local water regulations.

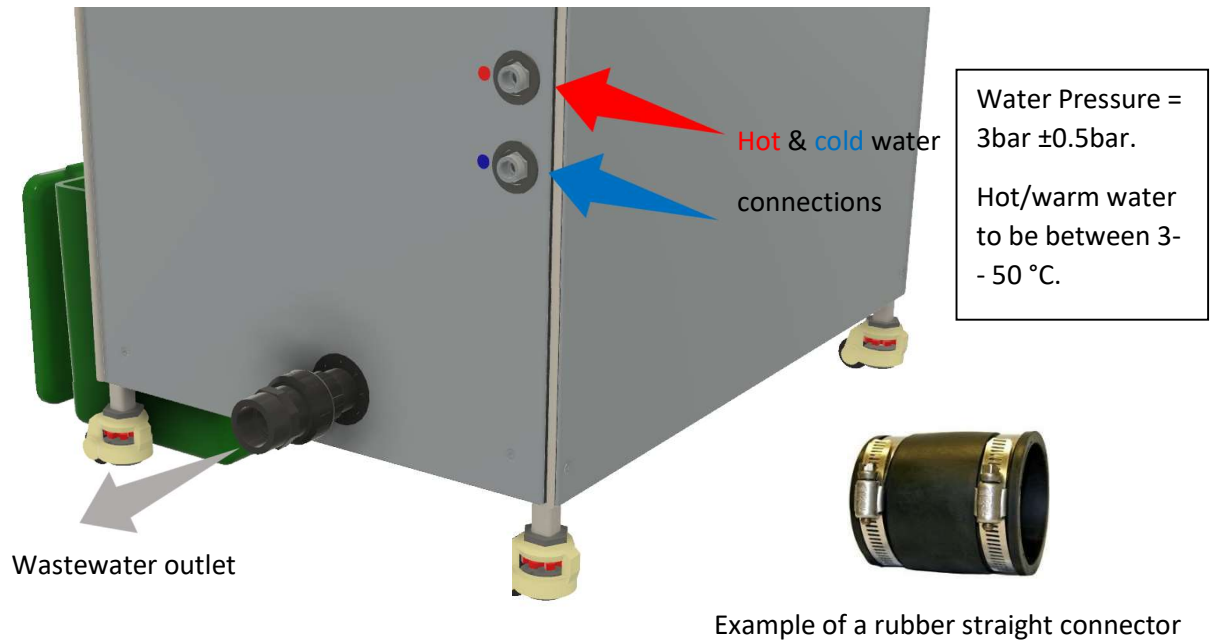

The drainpipe to be installed must slope downwards by 1% and fitted without a trap. It is not suggested these machines can be fitted with Grease Recovery Units (GRU's) but should be installed upstream of the sites grease trap.

Water flow sensors: these sensors prevent the machine from operating without water. If there is no water to either of the sensors a message will be displayed on the display screen.

Electrical Installation



IMPORTANT: All electrical installations must be performed by a qualified electrician in accordance with IEE Codes of Practice.

For safety reasons these instructions must be followed. Any deviation from these instructions will result in a breach of conditions of sale and voiding the warranty contract.

Examine the rating plate located as shown below to ensure that the characteristics shown are correct for the supply available.

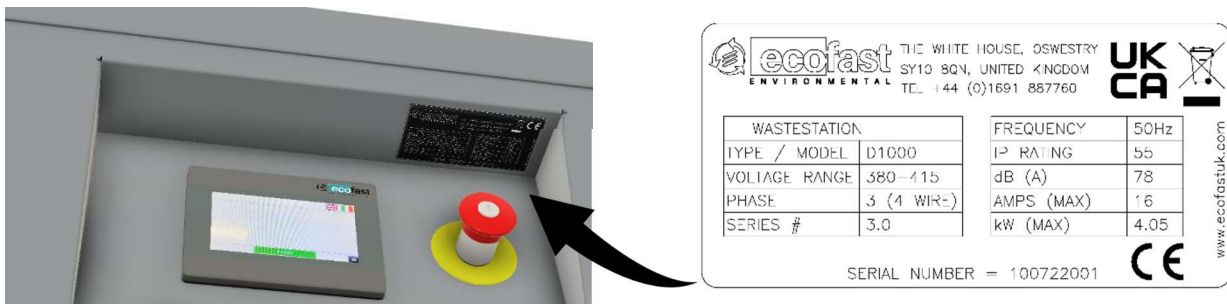

Location & example of the serial rating plate

The supply cable fitted is the minimum required for connection to the mains supply. Site conditions may vary with additional length of cable run, encapsulation in trunking, bunched with other cables etc. Should this apply, the electrician must alter the cable accordingly. **The WasteStation must be connected to a suitable 3-phase fused isolator providing at least 3mm separation in all poles.**

We recommend the WasteStation be connected to a wall mounted commando socket fused isolator. **The WasteStation MUST be connected to a 30A RCD.** The below illustrates typical fuse ratings for an ambient temperature of 25 to 35°C. Should the environment temperature be greater than this, adjust accordingly.



The supply to the machine must also be protected by a 30mA RCD.
WARNING: This machine must be earthed.



Mains cable wire identification labels

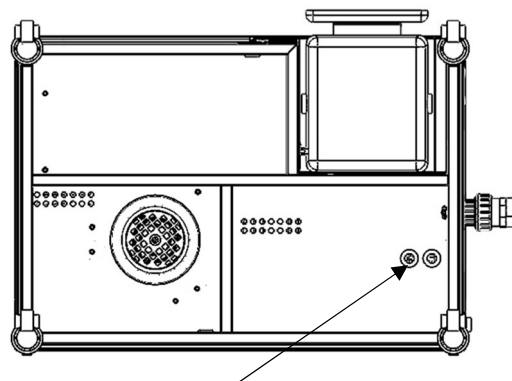

These holes on the underside of the WasteStation are for the power cable and the ethernet cable if fitted.

The D1000 WasteStation is supplied with a mains cable measuring 2m long.

If the supply cord becomes damaged, it must be replaced by qualified electrician in order to avoid a hazard.

Phase Sensor: the machine has a phase sensor to prevent the incorrect operation of the machine. In the event of the phases being in the incorrect orientation the machine will not operate and a "incorrect phase" message is displayed on the display screen.

TESTING

Check finally that all supply connections are correctly made and soundly fixed, that nothing has been left in the grinding chamber, that the rotor is free to rotate and that the baffle interlock is in the correct position.

Internet connection (if provided)

1. remove operator control panel (page 3)
2. run an ethernet cable through the cable entry hole on the bottom of the unit and up into the control panel.
3. insert the cable in the socket on the I/O panel's back (fig.3)

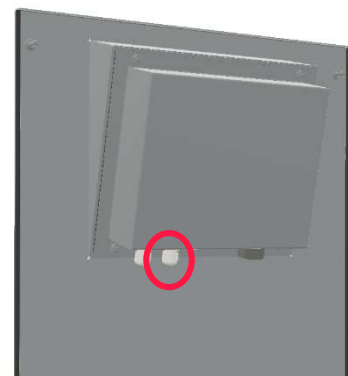

The machine is now ready to operate!

Operator Instructions (THIS WALL PLAQUE IS SUPPLIED WITH THE MACHINE)

WARNING - DO NOT

- Tamper with the machine in any way
- Insert anything but food waste into the hopper.
- Wash the machine by pressure jet.
- Use the machine in area with open flames!
- Operate the emergency button except in case of danger!
- Remove the rating label!
- Pour any Fats, Oils or Grease (FOG) into the machine!
- Pour any kind of soap, detergent
- Wash the lid in the washing machine.
- Use the machine wearing loose fitting clothing such as with large sleeves, scarves, ties, bracelets, necklaces.
- Sit on the machine or lay heavy objects on it.
- Leave anything in the hopper after use.

Operating or starting the Machine

Make sure the display shows "ready"

1. Press and hold the green button: the automatic cycle starts, and display shows "PROCESSING"
2. Introduce the food waste into the hopper at a steady pace. **DO NOT OVERLOAD** it and mix the food, **DO NOT ADD** large amount of one type of food it will block the machine.
3. The cycle automatically stops in a default time or by pressing the red button. When the display shows "stopping" don't introduce any food into the hopper and wait for the cycle to stop. Immediately after the machine has stopped it will undertake a quick automatic cleaning cycle before fully stopping.

Cleaning the Machine

At the end of the day, make sure the display shows "ready"

1. Open the baffle and ensure any left-over food waste is cleaned from the underside of the baffle and inside the cutting chamber, rinse with warm water & washing up liquid.
2. Remove the bin with the dewatered food waste and replace with an empty bin. This will ensure no water is introduced into the dewatered food waste.
3. Press and hold the blue cleaning button: the cleaning cycle will begin, the display will register the "CLEANING" message.
4. Clean and dry the external surfaces of the machine with a cloth ready for the next operation.

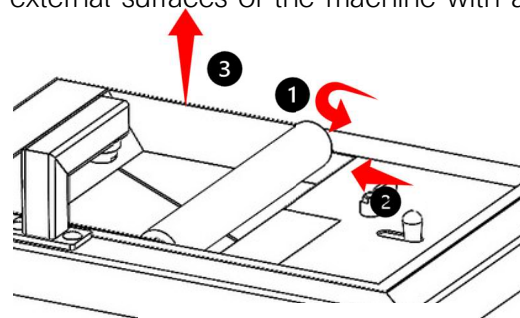

Removing the baffle

REFER TO THE DO'S AND DON'T POSTER/INFORMATION LOCATED ON PAGE 10 OF THIS MANUAL

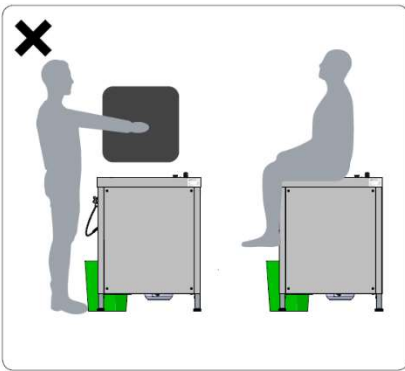
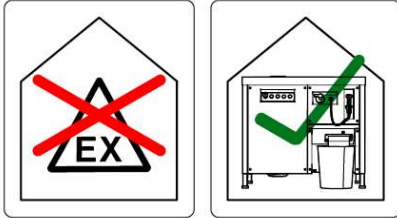
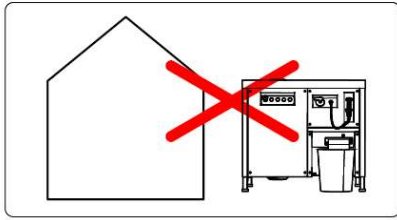

Do not sit or place heavy objects on the machine.

This D1000 WasteStation food waste management system and all Ecofast's products are designed to be operated inside a commercial kitchen or utility environment and **MUST NOT** be exposed to environmental elements.

The machine should be operator in conditions between 5°C to 35°C and between 20% to 80% humidity.

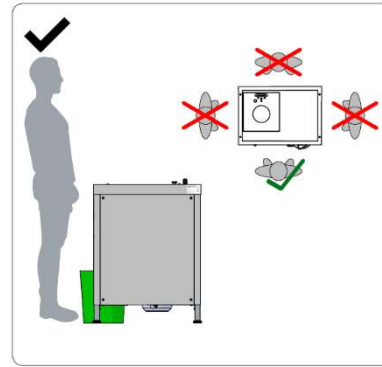

Correct positioning of the operator when using this machine.

Operation of the Ecofast products must be by a competent operator who has read this manual or undertaken the online training (the link is available by emailing info@ecofastuk.com).

Starting the Machine

To start the machine press and hold the start (green) button until the water starts running.

After this the macerator, pump and dewaterer will start up in this sequence.

The "PROCESSING" message will appear on the display.



Stopping the Machine

Once the food waste has been disposed of and the machine needs to be stopped simply press the stop button and the display will indicate the below message.







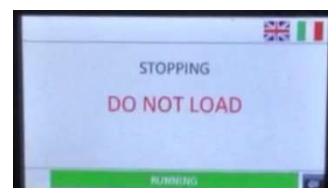











The machine will continue to run for a few seconds before initiating it's rinse cycle.

The rinse cycle is initiated automatically after each operation cycle to

prevent any obstructions being left in the macerating chamber, pump, dewaterer or the pipes.



Dos and Don'ts Poster

✓✓✓ YES	××× NO
<p>Plate scrapings</p> 	<p>Fibrous fruit & vegetables (ie pineapple crowns, corncobs & artichokes)</p> 
<p>Vegetable & fruit peelings</p> 	<p>Large bones in large quantities</p> 
<p>Fish</p> 	<p>Large volumes of cooked starchy products</p> 
<p>Meat</p> 	<p>Drink & Sauce sachets</p> 
<p>Vegetables</p> 	<p>Paper/plastic cups, stirrers & packaging.</p> 
<p>Fruit</p> 	<p>Cutlery</p> 
<p>Bread & Cakes</p> 	<p>Rubber Gloves</p> 
<p>Egg Shells & Dairy Products</p> 	<p>Cloths and towels</p> 
<p>Note: To assist the macerating process, during the maceration of large quantities of stringy and fibrous foods or large volumes of starchy foods, it is recommended to mix it with other food waste whilst adding to the hopper. This assists the flow of the macerated waste through to the waste pipes reducing the risk of potential blockages.</p>	<p>No Fats, Oils or grease</p>  <p>Paper & cloth napkins</p> 

The machine is intended to process food waste only.

Always process a mixture of materials and not just one type, especially if it is a dry material. Dry material must be fed into the hopper slowly to avoid blockages.

The following are considered improper use of this machinery:

- Inserting in the hopper material other than food waste
- Washing the machine by pressure jet or hose
- Installing and use the machine in area with high dust concentration or oily substances suspended in the air.
- Installing and use the machine in open air.
- Installing and use the machine in potentially explosive atmosphere or in area with open flames.
- Tampering the machine in any way.
- Operating the emergency button in absence of a real danger.
- Removing the identification label.
- Pouring any kind of soap or detergent into the hopper.
- Washing the lid in the washing machine.
- Using the machine wearing dresses with large sleeves, scarves, ties, bracelets and necklaces.

Bin Full.

The system operates a sensor that monitors the level of the dewatered food waste to prevent over filling of the bin.

If the bin full message is displayed on the operator display, the machine will stop working to prevent over filling.

Replace the bin with an empty one and press the start button to reset and restart the machine.

Once the operation has finished and the rinse cycle is initiated, there is a very fine spray that activates to clean the waste ejector. This will not alter the overall dewatered food waste as it is a very fine spray - refer to [Cleaning](#) of the machine for end of day procedure.

Emergency Stop Button is only to be used in an emergency & not as a way to stop the machine during normal operation. This isolates the machine and prevents any cleaning function taking place.

Operator Control Panel

Operator display indicating the system activity

Start button - press and hold to initiate

Cleaning button - to be used at the end of each day

Stop button - press and hold to initiate



Emergency Stop Button

Warranty Details

This product comes with a 2-year parts and labour warranty in the UK and 2 years parts only in exported regions. The warranty period is based on fair industry usage, regular service reviews in line with Ecofast recommendations or a maximum run time of 2,200 hours over the warranty period.

The product's onboard PLC (computer) will log running times which can be monitored remotely by Ecofast UK as an optional extra to provide a surveillance, problems solving and preventative maintenance service.

Spare Parts come with a limited 3-month parts only warranty from the point of purchase.

Trouble shooting & fault finding



Error fault codes – in the event of activation these error messages are display on the operator display.

Error Message	Corrective action
Motor overload	Isolate power to the machine, check for & remove any blockage, turn power back on. Wait for alarm to reset. Contact service dept if message continues.
No Water	Check water supply and restart – alarm will reset if water present
Phase error	Contact electrician for corrective action
Bin is full	Empty bin & restart machine
Emergency	Check baffle and bin are correctly fitted

Should the above corrective actions not overcome the faults, try the additional actions; **ISOLATE MACHINE**



Situation	Action
Object jammed in the macerator	Try unjamming the rotor by special tool EC000755. Remove the macerator and disassemble it to remove the jammed object. Replace the macerator
Bin is full but the machine doesn't stop; or display shows BIN FULL but the bin isn't full	Stop the machine, remove I/O panel and manually test the level sensor (page 10). Check whether led colour on sensor swaps together with display message. Check sensor's switch distances by hand. Replace the sensor.
Machine works but drops nothing into the bin	Press emergency button unplug power cord and remove possible clogging along the material's path. Run one or more cleaning cycles. Remove and inspect the dewaterer. Replace the dewaterer.
Macerator hopper is flooding	Stop the machine normally. Remove I/O panel and check for the pump to work. Check pump's wiring. Remove pump's cap and let the material out. Unjam and replace pump's impeller

Liquid leaks under the machine	Check macerator emergency drainpipe. If the macerator's emergency drain (pag.11) is leaking, replace the macerator.
Water falls into the bin during working cycle	Run one or several cleaning cycles. Unplug power cord and remove possible clogging along the material's path.

Spares Parts & Exploded Diagrams

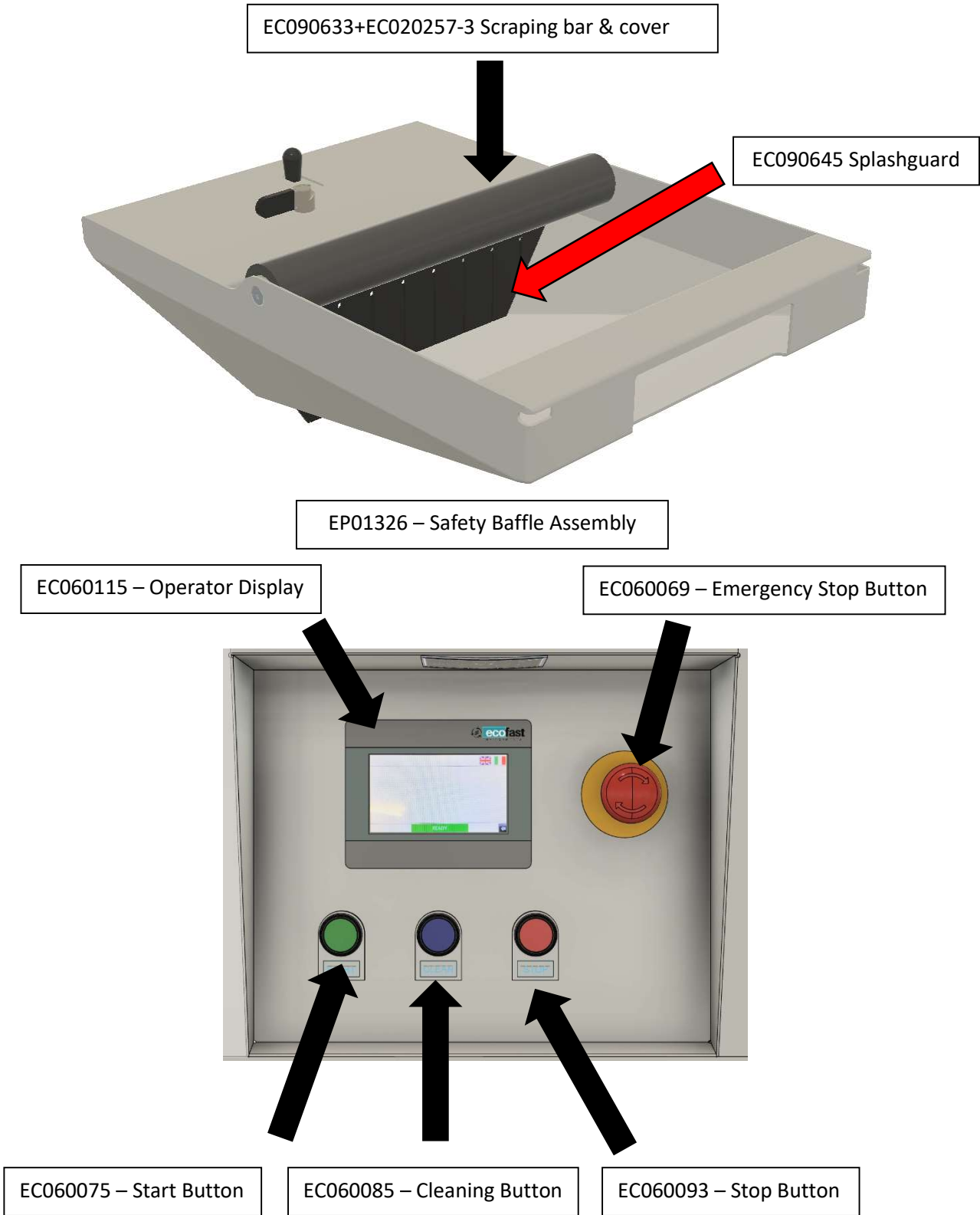

Water Delivery Assembly -
 (parts highlighted used on both cold & warm water assemblies)

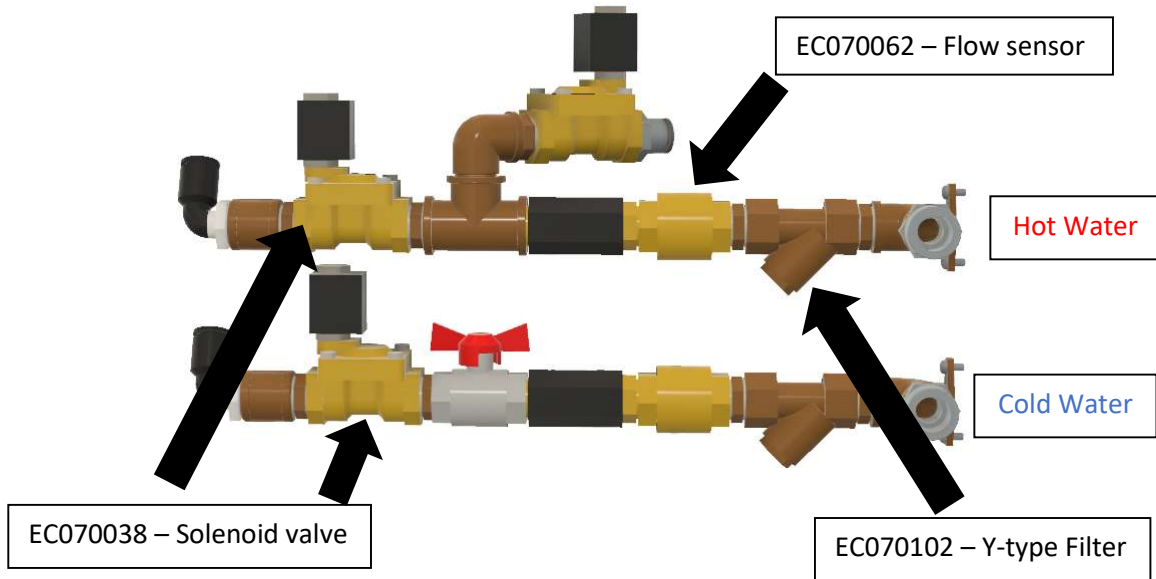

Macerator / Disposer Exploded diagram & Spare parts

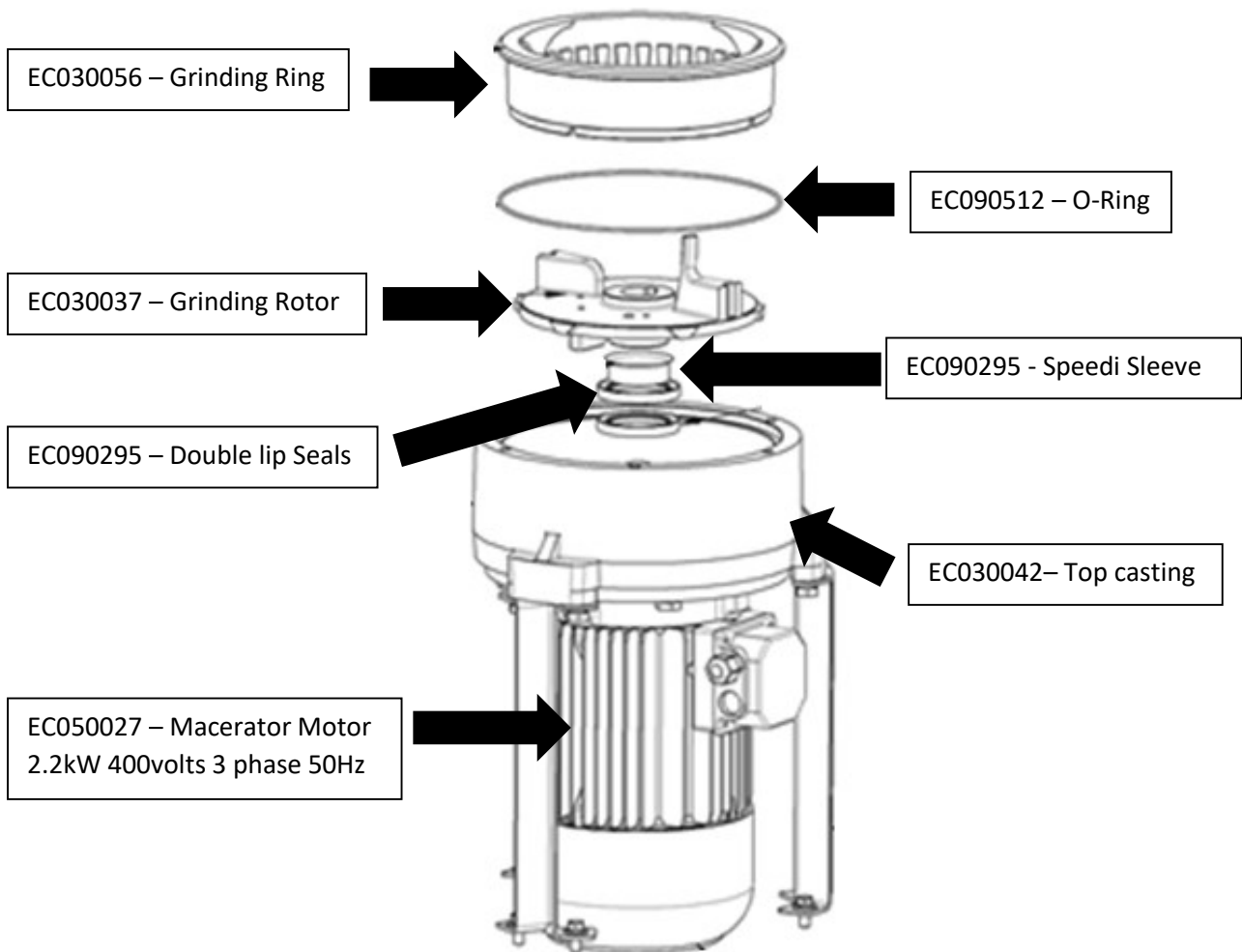

Pump Exploded Diagram & Spare Parts

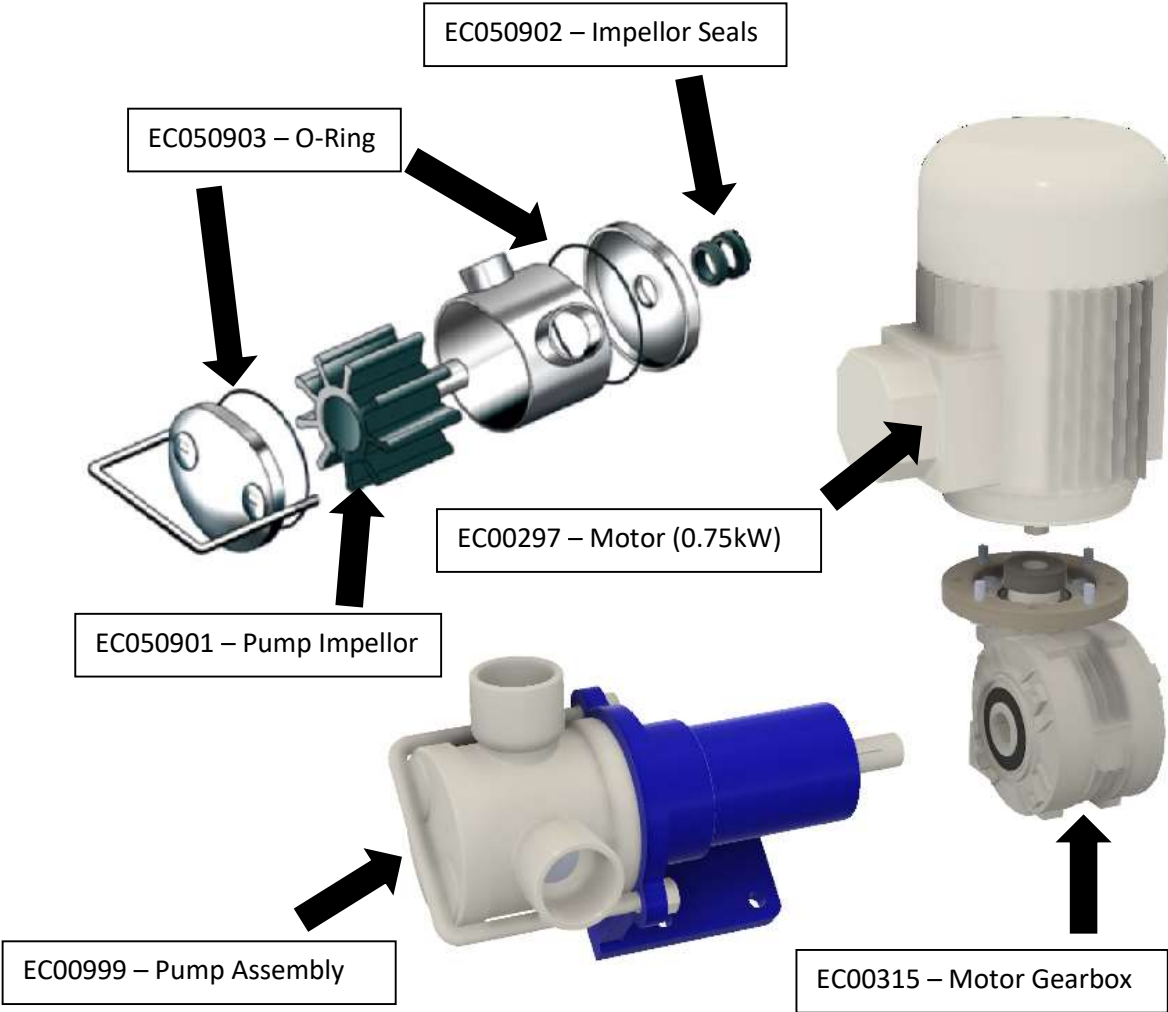

Dehydra (Dewaterer) & Spare Parts

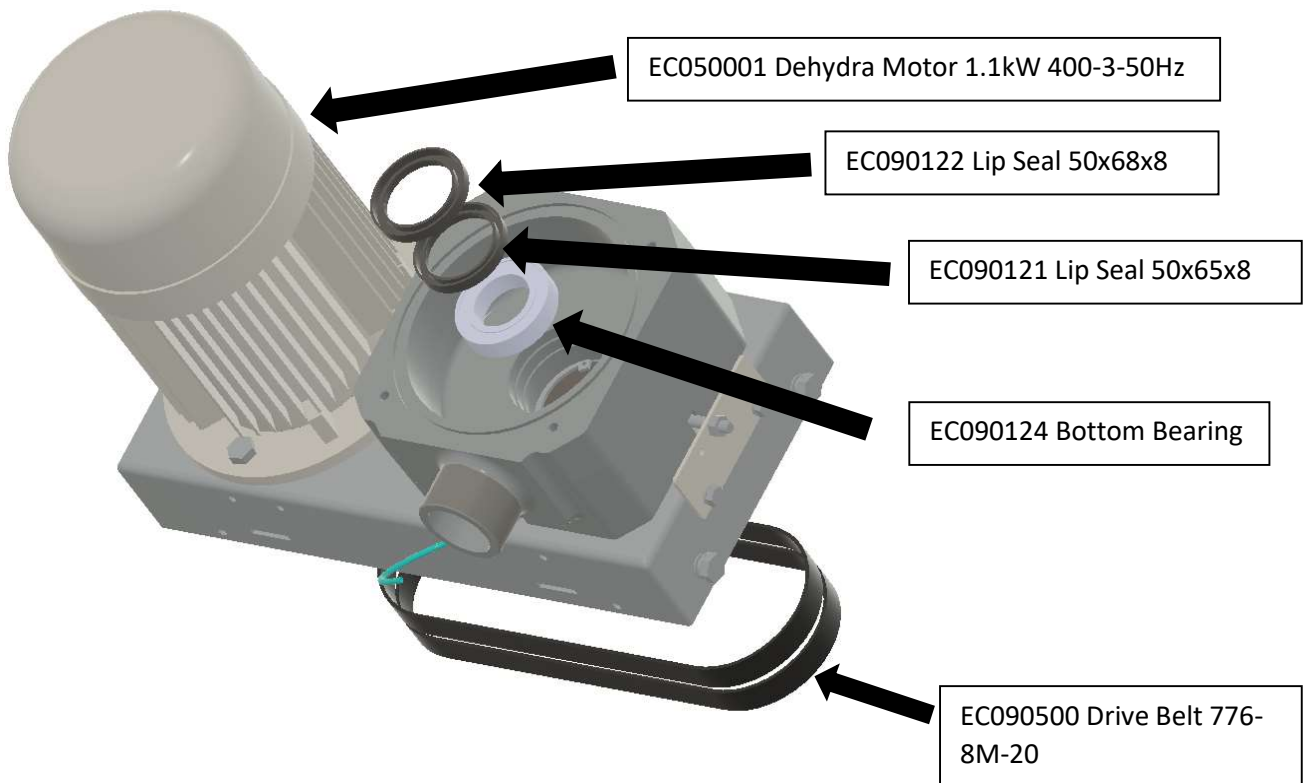
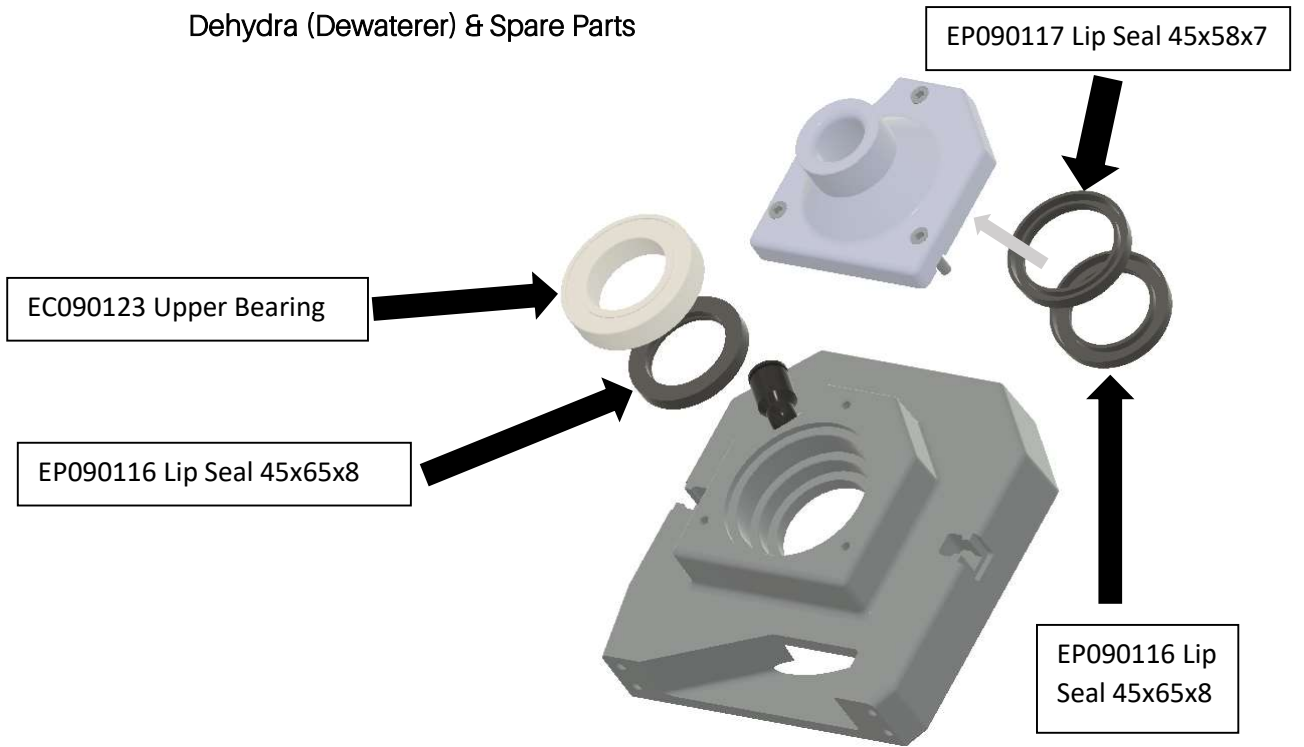

UKCA CERTIFICATE OF CONFORMANCE



Declaration of conformity

According to Directive 2006/42/EC, annex II point 1.A

The Designer & Manufacturer

*Ecofast Environmental UK Ltd
Maesbrook, Oswestry, SY10 8QN*

Hereby declares that the following machine:

D1000 WasteStation (SC1B)

complies with the following directives:

- 2006/42/EC - Machines Directive
- 2014/30/EU - EMC Directive
- 2011/65/EU - RoHS Directive

Name and address of the person authorized to manage the technical file:

Ecofast Environmental UK Ltd, Maesbrook, Oswestry, SY10 8QN

The main technical standards applied are

UNI EN ISO 12100:2010 Safety of machinery — General principles for design — Risk assessment and risk reduction

UNI EN ISO 13857:2008 Safety of machinery — Safety distances to prevent hazard zones being reached by upper and lower limbs

CEI EN 60204-1:2008 Safety of Machinery - Part 1 General Requirements CE Marking

UNI EN 14120:2015 - Safety of Machinery - Guards - General Requirements

ISO 12100:2010 - Safety of machinery — General principles for design — Risk assessment & risk reduction

EN 60204-1:2016 - Safety of machinery - Electrical equipment of machines - Part 1: General requirements

EN 1717:2000 - Protection against pollution of potable water in water installations and general requirements of devices to prevent pollution by backflow - refer to The Water Supply (Water Fittings) Regulations 1999

EN IEC 61000-6-2: 2019 - Electromagnetic compatibility (EMC) - Part 6-2: Generic standards - Immunity standard for industrial environments

Steven John Witt

Managing Director

CE CERTIFICATE OF CONFORMANCE

Declaration of conformity

According to Directive 2006/42/EC, annex II point 1.A

The Designer & Manufacturer:

*Ecofast Italia S.r.l. Tecnologie Ambientali
Piazza Franco Martelli, 5 - 20162 Milano*

Hereby declares that the following machine:

D1000 WasteStation (SC1B)

complies with the following directives:

- 2006/42/EC – Machines Directive
- 2014/30/EU – EMC Directive
- 2011/65/EU – RoHS Directive

Name and address of the person authorized to manage the technical file:

Ecofast Italia S.r.l. - Piazza Franco Martelli, 5 - 20162 Milano

Main technical standards applied:

- UNI EN ISO 12100:2010
- UNI EN ISO 13857:2008
- CEI EN 60204-1:2006
- UNI EN 953:2009
Milano,

The main technical standards applied are

EN ISO 12100:2010

EN 60204-1:2016

EN 1717:2000

EN 953:2009

EN 61000-6-2:2005

EN 61000-6-4:2007

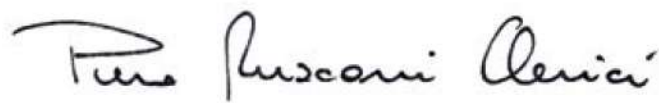

Ing. Piero Rusconi Clerici
CEO



MAINTENANCE MENU - RESTRICTED AREA – LOGIN

The display features a maintenance restricted area. Restricted area features orange background screens and a key on the left. To enter proceed as follows:

1	Touch the orange lock
2	Select SERVICE user and touch password
3	Type the password received from the manufacturer and press enter
4	Touch OK button. Below the password, a message displays password accuracy. Touch the arrow on the right
5	Touch the orange lock again, access is complete

Your machine may not have a password protection unless it was requested. If this is the case follow the instructions 1, click on the orange padlock and this will take you directly to routine maintenance page as shown on the next page.

It is advised that only service / maintenance staff access these pages.

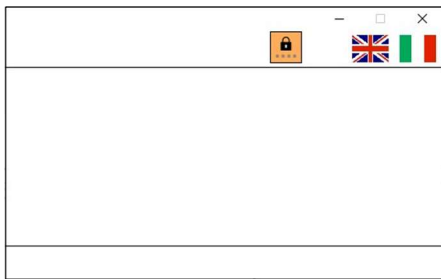

1

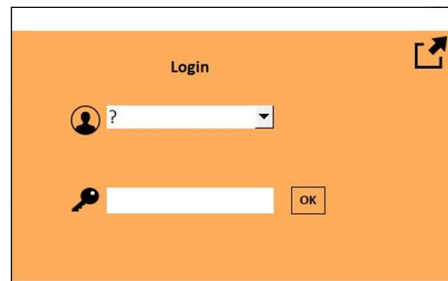

2

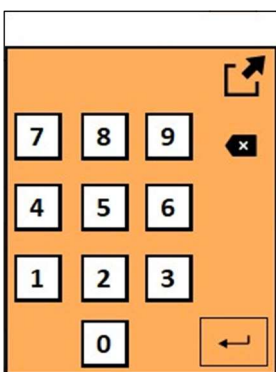

3

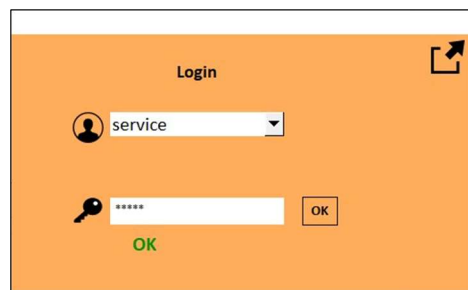

4

RESTRICTED AREA – FEATURES

Use black arrows on the bottom of the page to navigate the pages. In routine maintenance page, touching the left arrow will exit restricted area, back to main screen. Hereafter available screens are explained.

Routine maintenance

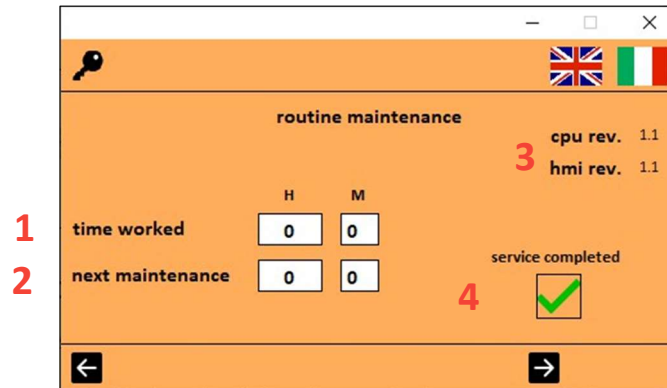

1	<i>Total worked hours</i>
2	<i>Time until next routine maintenance (pag.22)</i>
3	<i>Installed software review</i>
4	<i>Completed maintenance confirmation</i>

Motors

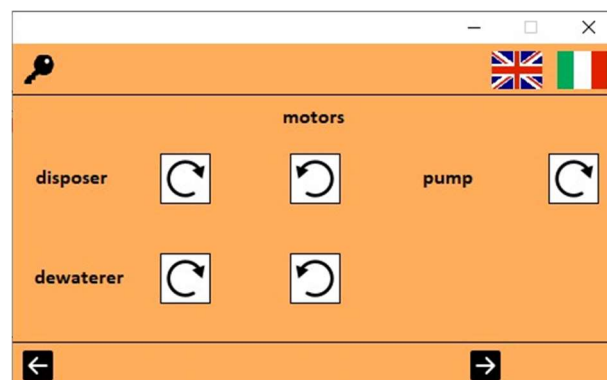

If needed, motors can be manually started by corresponding buttons. Macerator and dewaterer can rotate in both ways.



Touch only one button at a time!

Maintenance - Any maintenance should be undertaken by an approved Ecofast service agent.

When the display shows MAINTENANCE NEEDED, that must be carried out as soon as possible.

Maintenance times are reliant on the correct use of the machine, type of food waste, available water. Thus it's operator's duty to follow the timeframes of regular maintenance times based on these parameters. This paragraph refers to a correct use of the machine which follows the instructions in this manual.

When maintenance is over, ensure the castors are lowered and locked into the correct positions detailed in the installation section of this manual.

Pump service

Remove the pump unscrewing the 2 nuts (see red arrow), replace the impeller (1) and seals (2), inspect the O-rings (3) and replace if needed. If there is any damage to the pump assembly replace the whole assembly.

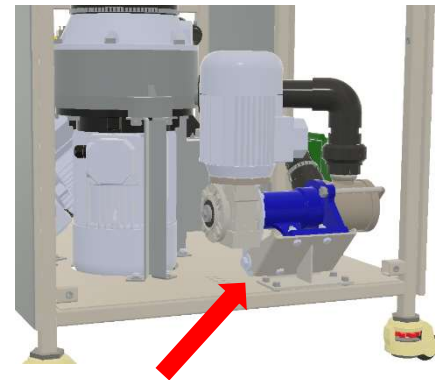
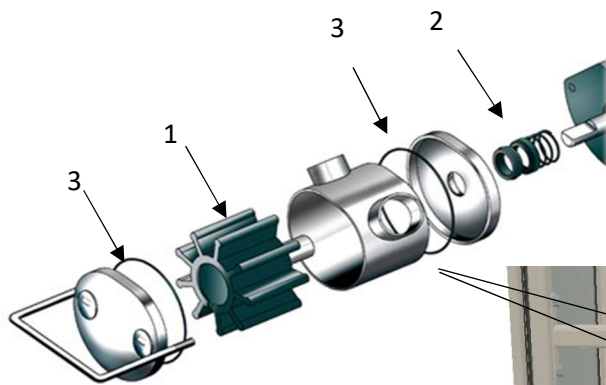

Clean filters

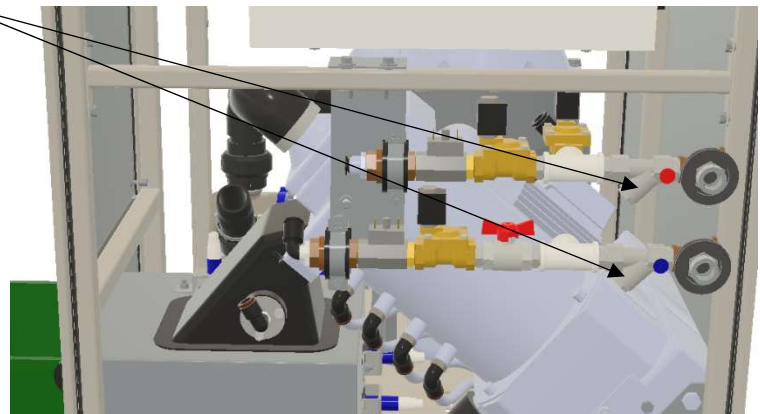

PLEASE NOTE: in new buildings it is possible the water system carries much debris at start up, it may be required to check the filters regularly.

Unscrew the caps at the bottom of the Y-type strainer & rinse out any debris. Replace the filter and ensure the caps are secured firmly in place.

General Inspection

Check warning labels and replace them if worn.

Macerator: check wear status of grinding rotor and ring, and replace them if needed. Replace seals in case of leakages. Ensure there is no water present in the leak pipe located coming out of the macerator casting.

Dewaterer: check to ensure there is no liquid in the leak detection pipe on the dewaterer base casting. Check for odd noise while rotating the belt and pulleys. If needed, replace the cylinder.

Non-routine maintenance



In the event of a breakdown of the machine, to prevent damage ensure the following actions are undertaken:

- ✓ Clean the machine as well as possible
- ✓ unplug the power cord
- ✓ apply an OUT OF ORDER / LOCK OFF label warning to the machine

Control panel removal



1. Isolate the power to the machine and apply a lock off safety tag prior to accessing the machine
2. Remove the front upper right hand panel
3. Push the control panel & bracket assembly up and inwards, this will allow the panel assembly to drop down and pulled forward to allow access.

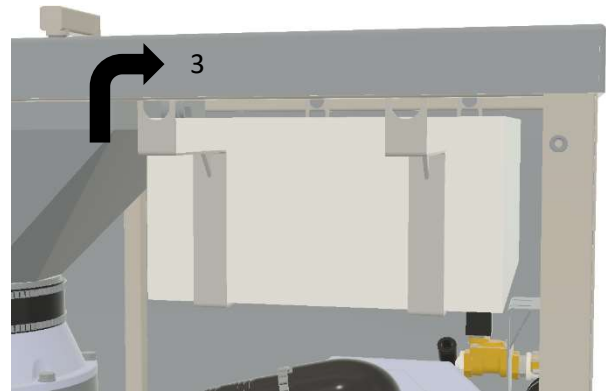

Pump Removal



1. Isolate the power to the machine and apply a lock off safety tag prior to accessing the machine
2. Remove both the side and front left-hand external panels
3. Disconnect both the inlet & outlet connectors and release the retaining bolts fixing the pump assembly in place

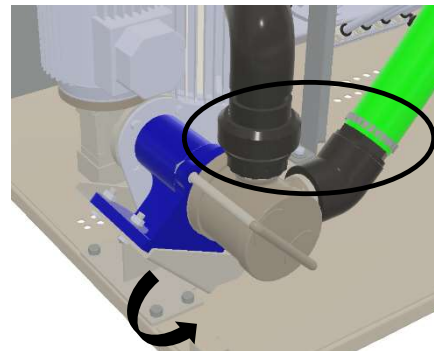
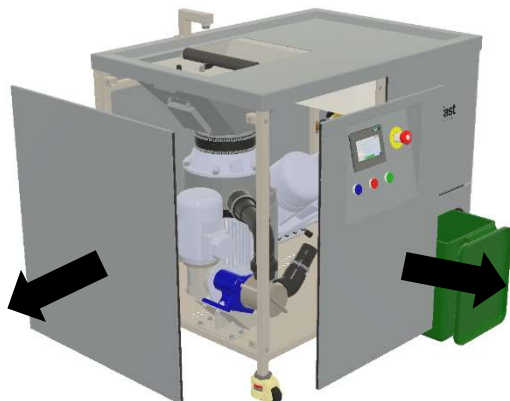

Macerator maintenance

Remove rear panel, disconnect macerator wires and pipes. Pull the macerator out towards machine's back and once macerator is clear of the WasteStation.

1. Loosen all 6 bolts to release the top cone
2. Lift the top cone
3. Remove the grinding ring and gasket
4. Using the EC000750 rotor release tool, extract the rotor from the motor top housing.

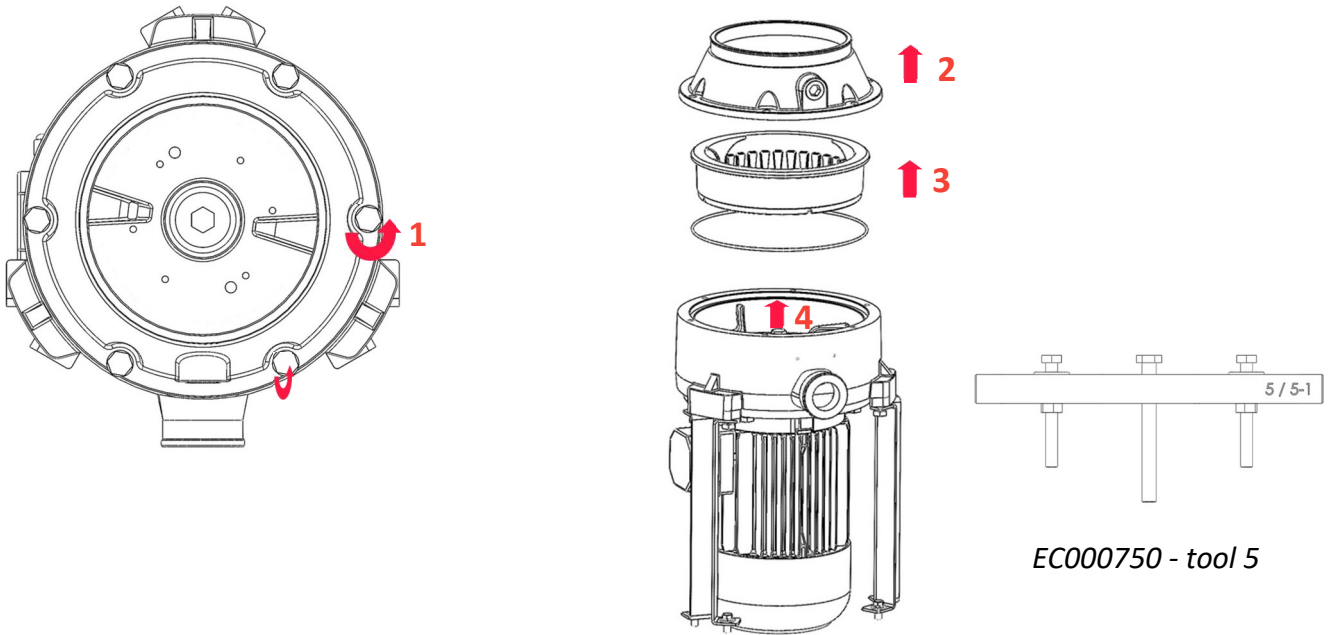

Dewaterer removal



1. Remove front, side, rear panels.
2. Disconnect and remove water supply assemblies, then side crossbar.
3. Disconnect the green pipe, remove the flange and manifold.
4. Disconnect all pipes from the dewaterer.
5. Unscrew and pull out the dewaterer.

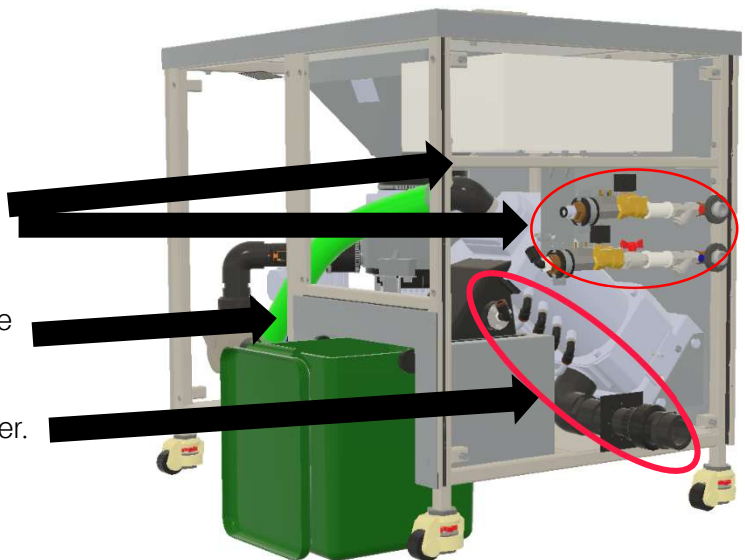

Accessing the Dewaterer belt & pulleys

1. Remove the rear panel to access the underside of the dewatering unit
2. Remove the dewatering service panel by unscrewing the two bolts and the panel will drop down, this will give access to both the pulley belts and the pulleys

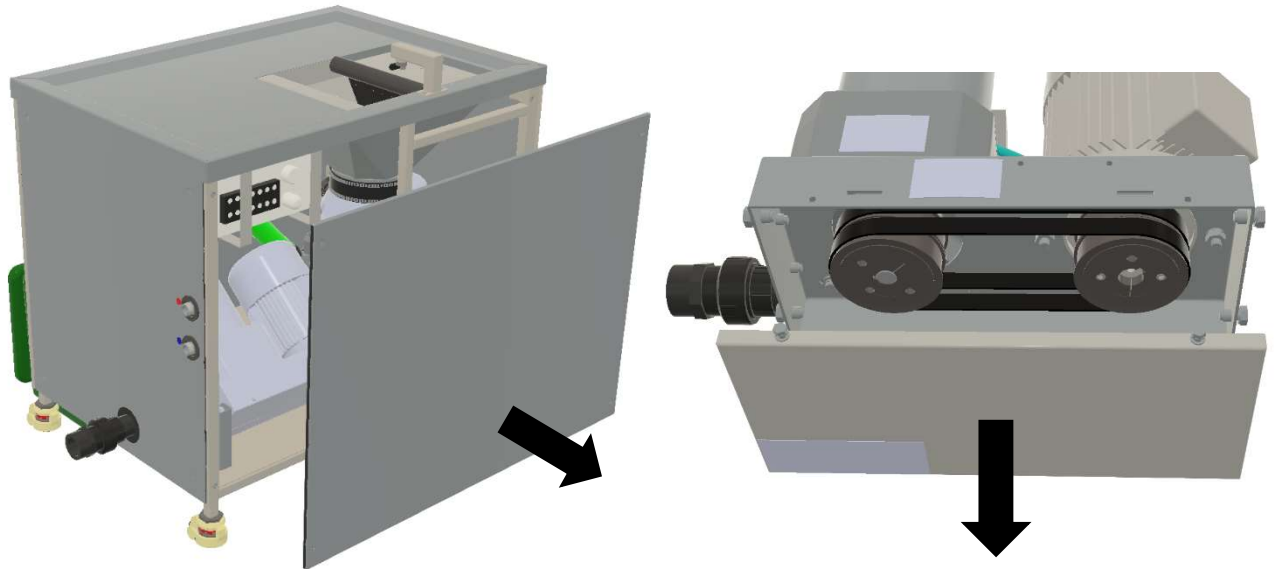

Accessing the Dewaterer top flange, seals and bearings

1. Remove the 3 off alum key to remove the top flange and expose the top of the auger assembly.
2. Within the flange removed there is two seals EP090117 (45x58x7) and EP090116 Lip Seal 45x65x8.

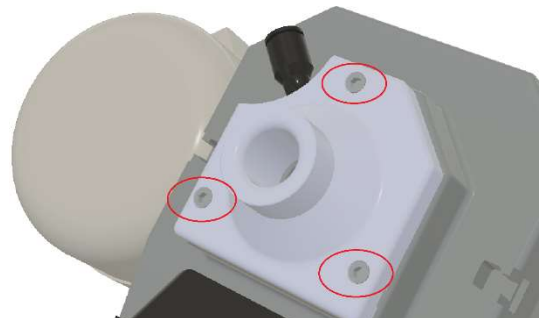

3. To remove the top housing assembly unscrew the 4 off Alum screws securing the top housing to the stainless steel body.

4. This will give access to the top bearing EP090123 and Lip Seal EP090116 (45x65x8) shown below.



Accessing the Dewaterer bottom flange, seals and bearings

1. To access the bottom flange assembly, the top flange needs to be removed as detailed above and the stainless steel body needs to be removed.
2. To remove the auger, remove the belt and pulley assemblies from underneath the main flange assembly, this will allow access and removal of the bottom bearing and seals.

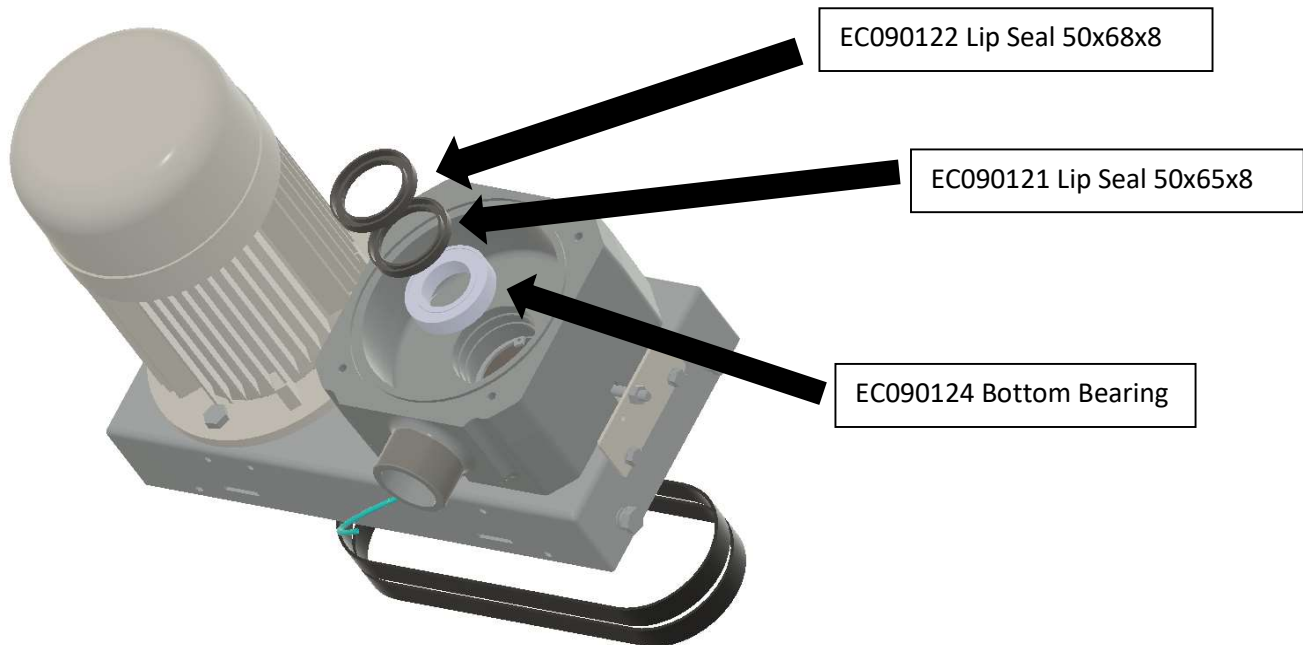

Where to find further help / contact details

We at Ecofast are here to help! Within the UK we have over 20 years of Food Waste Management design, project installation and servicing knowledge.

We have offices in the UK, Italy, Dubai and China. Our Research and Design facility is based in Milan, Italy and the production facility is spread between the UK and Italy.

Our UK contact details are

Ecofast Environmental UK Ltd (Factory Address);

Haygarth Park, Blaenau Ffestiniog LL41 3PF

Office phone number - +44 (0)1691 887760

Website - www.ecofastuk.com

Email addresses -

info@ecofastuk.com

steve@ecofastuk.com



@EcofastUK



ecofastenvironmentalukltd

Disposal of machine / end of life actions

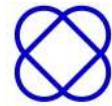

LOOPCYCLE

European Directive 2012/19/EU, when the machine is to be decommissioned it must be disposed separately from other waste.

Proceed as follows:

1. Remove and dispose of the machine rating label & manual
2. deliver the machine to a special collection centre for electric and electronic waste.

Illegal disposal of the machine implies financial sanctions as stated by the laws in force.

Ecofast Environmental UK Ltd partner with LOOPCYCLE who are specialists in end-to-end asset disposal services; providing businesses and government institutions with a simple, compliant and sustainable solution.



Scan the Loopcycle QR code on you machine to explore ways you can reduce your impact on the environment and contribute to the circular economy.

Maintenance Record

Data	
Task & description of work	
Next service date	
Service company	
Signature	

Data	
Task & description of work	
Next service date	
Service company	
Signature	

Data	
Task & description of work	
Next service date	
Service company	
Signature	